



00-0001526

Department of Energy

Washington, DC 20585

July 30, 2000

RECEIVED
00 AUG -3 PM 2:53
DNF SAFETY BOARD

The Honorable John T. Conway
Chairman
Defense Nuclear Facilities Safety Board
625 Indiana Avenue, NW.
Suite 700
Washington, D.C. 20004-2901

Dear Mr. Chairman:

In letters dated March 30, 2000, and May 30, 2000, the Board expressed concerns related to the design and construction of the Hydrogen Fluoride Supply System (HFSS) project at the Y-12 Plant in Oak Ridge, Tennessee. The enclosed document addresses concerns detailed in the correspondence discussed above and provides the current status of HFSS design and construction.

Additionally, on July 14, 2000, the site forwarded a "Mission Assurance Plan" to Headquarters. This plan proposes a path forward for enriched uranium operations at Y-12 and was reviewed "in draft" by an onsite Board staff member. The plan is currently under review by the Department of Energy. We will keep the Board and its staff informed of significant developments relating to resumption of enriched uranium operations, including the HFSS process.

If there are questions, please contact me or have your staff contact Xavier Ascanio at 301-903-3757.

Sincerely,

A handwritten signature in black ink, appearing to read "Madelyn R. Creedon".

Madelyn R. Creedon
Deputy Administrator
for Defense Programs

Enclosure

cc w/enclosure:
M. Whitaker, S-3.1

memorandum

DATE: June 23, 2000

BY TO:
FROM OF: DP-83:Rhyne

SUBJECT: DEFENSE NUCLEAR FACILITIES SAFETY BOARD (DNFSB) REVIEWS OF THE Y-12 HYDROGEN FLUORIDE SUPPLY SYSTEM (HFSS)

TO: Xavier Ascanio, Director of Site Operations, DP-24, GTN

DNFSB correspondence dated March 30, 2000 relayed the Board's concern with the Y-12 HFSS design, construction, operating characteristics, and failure modes. Since that time, the five member DNFSB Board has visited Y-12 and received a briefing on the HFSS, two of the Board members visited Y-12 again to review Enriched Uranium Operations restart efforts, and DNFSB staff have performed a review of the HFSS. Additionally, the DNFSB issued a letter dated May 30, 2000 recommending that the Natural Phenomena Hazards design of certain sections of the HFSS be reevaluated for more stringent controls.

Attached is a letter from Lockheed Martin Energy Systems addressing many of the Board's concerns outlined in the correspondence discussed above, and detailing the present status of the HFSS design and construction.

If there are any questions, please have your staff contact Ken Rhyne at (865) 576-9901.

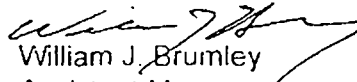
William J. Brumley
Assistant Manager
for Defense Programs

1 Attachment

cc w/attachment:

P. Aiken, HQ, DP-24, GTN

T. Hinkel, NADP-68, ORO

Lockheed Martin Energy Systems

Post Office Box 2009 Oak Ridge, Tennessee 37831 - 8193
Telephone: 865/574-2066 Facsimile: 865/576-4846

LOCKHEED MARTIN 

June 6, 2000

Mr. William J. Brumley
Assistant Manager for Defense Programs
Department of Energy, Oak Ridge Operations
Post Office Box 2001
Oak Ridge, Tennessee 37831

Dear Mr. Brumley:

**Contract DE-AC05-84OR21400, Response to the Defense Nuclear Facilities
Safety Board (DNFSB) Review of the Hydrogen Fluoride Supply System (HFSS)**

- References: (1) Conway to Gioconda letters dated March 30, 2000, and May 30, 2000
(2) Beck to Brumley letter dated April 24, 2000, *Fiscal Year 2000 Stockpile
Management Operating Guidance*
(3) Beck to Brumley letter dated May 16, 2000, *Enriched Uranium Operations
Resumption Plan Baseline*

In response to the Conway to Gioconda letter dated March 30, 2000, enclosed is a proposed response to the issues raised by the DNFSB on the HFSS.

Reference 1 forwarded a DNFSB Staff Issue Report on instrumentation and controls for the HFSS at the Y-12 Plant. The Staff Issue Report contains a subset of the technical issues that have been reviewed with DNFSB staff and board members during recent months including the visits in April and May. Y-12 personnel are currently working on an integrated approach to address all known safety, quality, operation, and construction issues with the HFSS. It is recognized that hydrogen fluoride (HF) represents a significant chemical hazard; and we are committed to ensuring that the system is designed, installed, tested, and that training is provided as necessary for safe operation. The new system is a vast improvement over the system used in the 1970s and 1980s. The system's design provides defense-in-depth (refer to enclosure) and incorporates technologies (HF detectors, automatic controls, and off-gas scrubbers) to enhance worker and public safety that were not used in the earlier system. However, problems did emerge during execution of the project that installed this system.

Current activities on HFSS are focused on resolving the procurement, fabrication, and installation deficiencies; updating the safety basis; confirming the technical baseline; and completing the start-up testing. The present effort includes reassembly of the fluid beds which were disassembled

June 6, 2000

to allow for cleanup and modifications after the surrogate material testing. Welding and material compatibility issues are also being addressed.

The technical baseline effort (described in enclosure) has completed the identification of design requirements and is well into the development of documentation packages that demonstrate that the requirements are met. Discrepancies identified during this effort have been documented and are being tracked to closure. The most significant deficiency relates to the natural phenomena hazards design and qualification of the system. To address this deficiency, Y-12 personnel have developed a mitigation strategy which will ensure that the components with large inventories of HF (cylinder, superheater, and vaporizer) satisfy PC-3 requirements. Other system components will be qualified to a level commensurate with their safety function.

*but not
isolated !!*

Technical reviews have also identified concerns with the instrumentation and control components as described in the Staff Issue Report. The strategy for resolution of these issues will include finalizing design criteria (draft criteria were provided to DNFSB staff during the April site visit), comparing the existing designs to these criteria, evaluating deviations from the criteria, and implementing improvements, as appropriate.

The start-up testing program for HFSS will be expanded to address requirements identified in the technical baseline effort that require testing (versus documentation reviews or walkdowns). The testing program has been developed to allow use/validation of operating procedures and to provide 'hands-on' experience for the operations staff. The testing program will be followed by a drill program that addresses both normal and off-normal events.

The activities described herein are part of an overall strategy that will address outstanding items (including those discussed with the DNFSB staff during the April and May visits) associated with the HFSS. The strategy is being revised to assure safety while accommodating the recent budget reductions and meeting the requirement of a September 2001 startup (References 2 and 3). In order to properly balance these objectives, a formal screening process is being developed. This process will identify the pre-startup requirements and requirements to be implemented in the first and second outages following startup. The screening criteria and final results will be approved by the Operational Safety Board and submitted to the Department of Energy for approval.

Lockheed Martin Energy Systems recognizes the significant hazard that HF represents and is committed to resolving all outstanding technical concerns. The enclosure provides information on HF, the system, and plans to address the generic issues.

Mr. William J. Brumley, DOE-ORO

Page 3

June 6, 2000

If you have questions or require additional information, please contact W. A. Heineken, 576-3803,
or K. D. Keith, 576-9687.

Sincerely,

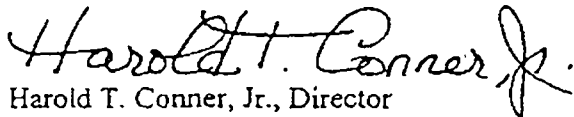

Harold T. Conner, Jr., Director
Enriched Uranium Operations and Restart

HTC;jj

Enclosure: As Stated

cc/enc: E. J. Bergin
D. E. Christenson, DOE-ORO
C. K. Collier
H. T. Conner, Jr.
D. F. Craig/E. G. St. Clair
EUO-DMC (RC)
G. F. Hagan
S. E. Hartson, DOE-ORO
W. A. Heineken
J. W. Insalaco
K. D. Ivey, DOE-ORO
K. D. Keith
L. G. Loden
G. L. Lovelace
T. B. Oberding, DOE-ORO
J. E. Stone
R. I. Van Hook
S. A. Watkins, DOE-ORO
S. E. Wellbaum, DOE-ORO

Hydrogen Fluoride Supply System (HFSS) Defense-in-Depth

Background

Enriched Uranium Operations (EUO) at the Y-12 Plant are critical to Defense Program missions and are not duplicated anywhere in the Complex. The HFSS is a key element in enriched uranium processing. In 1992, a significant hydrogen fluoride (HF) release occurred; and as a result, a new supply system has been designed and is in the process of final installation. The new system incorporates many design improvements over the original system, but issues have plagued the HFSS project¹. To ensure that safe operation is possible, safety analyses were completed and are summarized in the *Basis for Interim Operation for Building 9212 Enriched Uranium Operation Complex*². A technical baseline recovery effort³ is currently confirming that design input and safety requirements have been properly incorporated into the as-built system.

This paper describes the improvements and the defense-in-depth features incorporated into the new design. Information on the basic hazards associated with HF, the earlier system designs, and previous events is also provided.

HF

Anhydrous HF is normally a colorless, fuming gas that can also exist as a liquid or in aqueous solutions as hydrofluoric acid. HF is reactive in moist air and is corrosive and toxic to humans. The odor is pungent and detectable in the 0.04-0.13 ppm range. The Emergency Planning Release Guides⁴ (EPRG) are:

- | | |
|--|------------|
| 1. EPRG-1 (<i>OSHA Personnel Exposure Limit</i>) | 2 to 3 ppm |
| 2. EPRG-2 (<i>1 hour exposure w/o irreversible damage</i>) | 20 ppm |
| 3. EPRG-3 (<i>1 hour exposure is non-life threatening</i>) | 50 ppm |

HF is used across the world in uranium enrichment processes, as well as in the aluminum, glass, and petroleum refining industry. In these industrial facilities, HF is typically delivered in 12,000-gallon railroad tank cars⁵ or in 55-gallon drums as hydrofluoric acid. For example, the DuPont-Corpus Christi, Texas, facilities have approximately 40 million pounds of hydrofluoric acid yielding worst-case, unmitigated releases that could expose hundreds of thousands of people to fifty times the EPRG-3 (50 ppm).⁶ While less than 1,000 pounds will be in use, EUO recognizes that HF is a significant chemical hazard and

¹ *Independent Assessment of the Hydrogen Fluoride Supply System Project*, Y/MA-7534, August 4, 1999

² *Basis for Interim Operation for Building 9212 Enriched Uranium Operation Complex*, Y/MA-7254, Revision 7, January 2000

³ *Hydrogen Fluoride Supply System Baseline Review Plan*, Y/MA-7616, January 2000

⁴ *ibid.*, 2, pages 5-6

⁵ *Uranium Production Technology*, D. Van Nostrand Company, Inc., Princeton, NJ, 1959

⁶ *Accident Release Vulnerability Zones for Ten DuPont Facilities*, www.rtk.net/wcs

is committed to implementing the controls necessary to ensure safe operation. The new system design provides containment (cylinder) and confinement (enclosures and scrubbers) features that meet or exceed industry practices.

HF can be neutralized with water and alkaline solutions such as potassium hydroxide. Engineered features commonly used with HF include containment, confinement, and leak detection equipment. Personnel protective measures for HF handling include well ventilated areas, prevention of skin or eye contact, and the use of respirators or positive air-supplied equipment⁷.

Earlier HFSS Design

In 1992, a release of 600 pounds of HF occurred when a rupture disk failed concurrent with a downstream valve being mispositioned⁸. The downstream valve allowed HF liquid to escape onto the room floor and to an outside dock area. The room was not designed as air tight, so HF fumes escaped the area. This Category II (unusual) event did not result in any irreversible, adverse affects to the workers or public because the release occurred in January with low ambient temperatures which minimized HF vaporization. The HFSS design, at the time of the event, did not include containment features nor scrubbers to prevent and mitigate potential events. As a result of investigations following this event, a line item project to replace the entire HFSS was initiated.

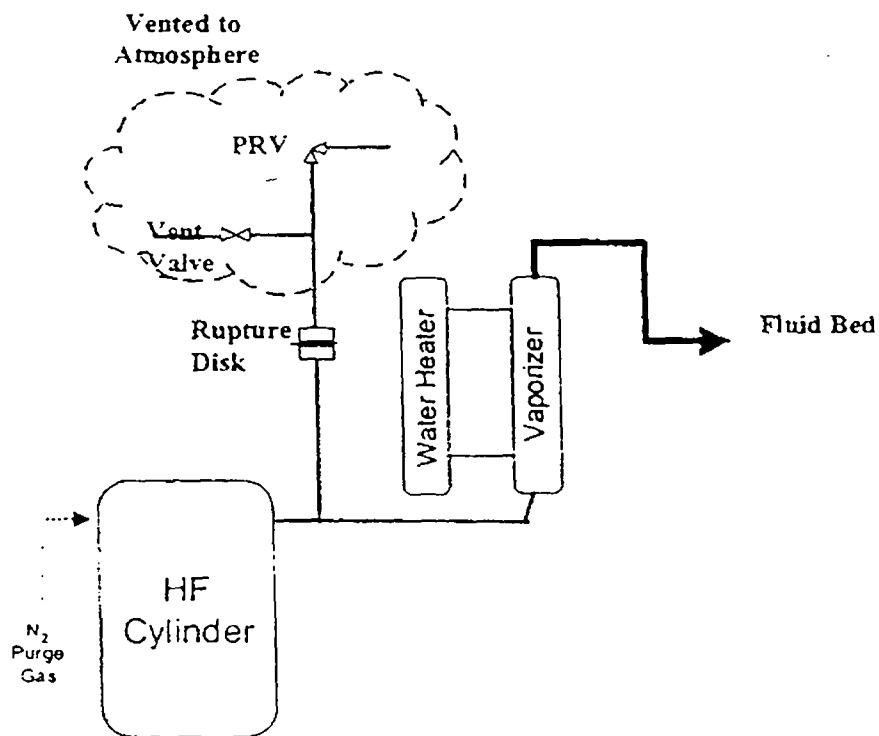

⁷ NIOSH Pocket Guide to Chemical Hazards, CAAS 7664-39-3 (www.cdc.gov/niosh/npg/npgd0334.html)

⁸ Type B Investigation, *Anhydrous Hydrogen Fluoride Release to the Environment*, February 1992

Current HFSS Design

The new HFSS design eliminated direct leak paths to the environment and incorporated many safety features including use of a Department of Transportation approved supply cylinder, robustly designed process vessels, secondary enclosures for equipment, a sump tank to collect and contain potential liquid spills, double-walled piping outside the enclosures, scrubbers for process offgas, and enclosures where spills could occur⁹.

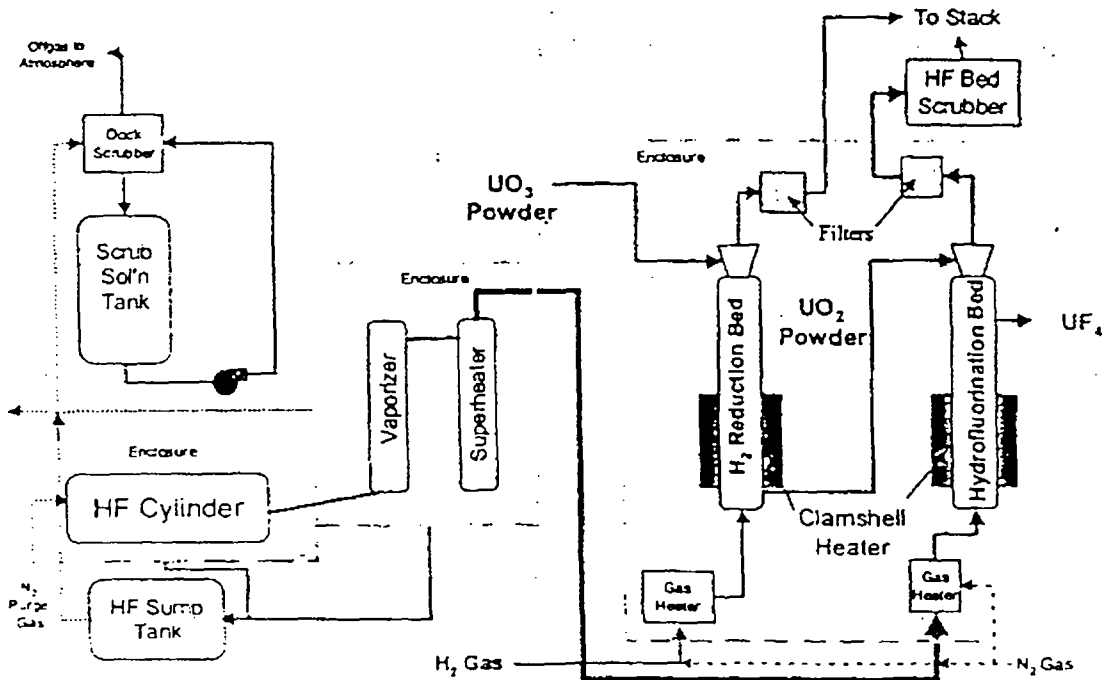

HFSS Safety Analyses

The HFSS safety analysis and design process were not well integrated during the design phase and early construction effort¹⁰. Since that time, a hazard evaluation and the safety analyses have been completed as documented in the *Basis for Interim Operation (BIO)*¹¹. Additional work is planned on the safety analyses to reconcile issues from the technical baseline effort and other reviews.

The protection against a release of HF can be viewed as a series of barriers establishing defense-in-depth. The main process piping is the primary barrier (P). The enclosures, sump tank, transfer line, outer wall, and scrubbers make up the secondary boundary (S). The third boundary is composed of software interlocks, leak detection alarms, procedures, and operator actions (T).

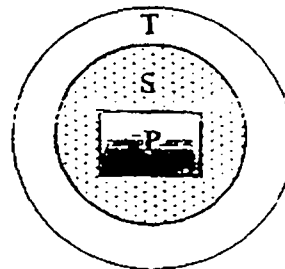

⁹ Process System Diagrams, HF-P1 to 7 and FB-P1 to 7

¹⁰ *ibid.* 1

¹¹ *ibid.* 2, Chapter 5

The amount of material at risk and various operating modes must be taken into consideration. The BIO analyses a wide range of events including an unmitigated, total release of the HF supply cylinder (the cylinder has a design capacity of 1,350 pounds but is administratively controlled to 900 pounds). The BIO analyses indicated that a release of HF in quantities greater than five pounds could, in severe meteorological conditions, exceed EPRG-2 values at the site boundary. The amounts of material at risk in the system include:

- | | |
|-------------------------|---------------------------------------|
| 1. Supply Cylinder | 900 pounds (maximum credible release) |
| 2. Supply Cylinder Heel | 170 pounds |
| 3. Vaporizer Batch | 160 pounds |
| 4. Vaporizer Heel | 30 pounds |
| 5. Transfer Line | <1 pound |

These quantities can be compared to other industrial hazards (ammonia, chlorine, or other hazardous gas releases)¹².

Risk Bins

> EPRG-2	II	I	I
	III	II	I
<EPRG-2	IV	III	III

Very Unlikely Anticipated
Unlikely
<10E-4 10E-4 to .01 >.01

A hazards evaluation was performed to identify hazards and accident initiators. The results of the accidents analyses are summarized in the BIO. The summaries include the frequency, consequence, risk bin, receptor, available controls (defense-in-depth features) and the controls credited in the safety analyses. Scenarios which, if unmitigated, fall into Risk Bins I or II are considered 'dominant' and credited preventive/mitigative measures are controlled via the *Operational Safety Requirements for Building 9212*.¹³

The primary components (cylinder, vaporizer/superheater, transfer line, and fluid beds) are fully enclosed in an outer confinement boundary with leak/HF detection provided. The primary components can be nitrogen purged and are protected from nitrogen over pressurization by a pressure regulator set at 20 psig and a pressure relief valve set at 24 psig. These nitrogen supply pressure relief components are protected from HF backflow by redundant check valves. Unlike the older system design, the system pressure relief components vent to the dock scrubber intake instead of directly to the environment.

The technical baseline effort will ensure that components with large volumes of HF (cylinder and vaporizer/superheater) are upgraded to meet PC-3 Natural Phenomena Hazards requirements.

¹² Environmental Protection Agency *Risk Management Plans* (examples include 10844LA, 12631TN, 11739FL, 13162TX, 2740TX, 11133AL) accessed via www.rtk.net

¹³ *Operational Safety Requirements for Building 9212*, Y/MA-7255, Revision 14, January 2000

The secondary confinement consists of:

- Cylinder is inside the cylinder enclosure which is kept at greater than 0.25-inch water column vacuum by the dock scrubber – leaking liquid is captured and routed to the sump tank.
- Vaporizer and superheater are inside an enclosure also kept under negative pressure by the dock scrubber – leaking liquid is captured and routed to the sump tank.
- Transfer line is a double-walled pipe and the annulus is pressurized with nitrogen – a loss of nitrogen pressure isolates the HF supply.
- Fluid bed is inside an enclosure which is kept at a negative pressure by a high-efficiency particulate air filtered (not scrubbed) ventilation system – HF detectors in the enclosure are interlocked with the HF supply.

These secondary confinement features provide assurance that, in the unlikely event of a primary containment failure, the leakage is controlled and/or isolated.

Operation of the HFSS and associated fluid bed requires portions of the primary containment boundary to be vented. The modes and vent paths include:

- Operation
 - Vaporizer filling – HF is transferred from the supply cylinder to the vaporizer by pressurizing the cylinder with nitrogen and venting the top of the vaporizer to the dock scrubber intake. The vaporizer is isolated from the cylinder after filling, and the vent valve is closed.
 - Fluid bed reaction – HF is transferred from the vaporizer/superheater through the transfer line to the preheater and fluid bed. The fluid bed is vented to the B-1 Wing scrubber intake.
 - Vaporizer draining – HF is gravity drained from the vaporizer to the cylinder with the nitrogen feed line vented to the dock scrubber intake.
 - Pre-maintenance purging – HF is purged from the primary containment components prior to maintenance. When purging, nitrogen is supplied and HF is vented to the scrubber systems.
- Warm Standby – *no transfer of HF is allowed*¹⁴
- Cold Standby – *no transfer of HF is allowed*

The scrubbers must be confirmed operable prior to vaporizer filling, fluid bed reaction, or pre-maintenance purging¹⁵. During these time periods, the scrubbers (up to the packed bed) form part of the primary containment boundary. A safety (hardwired) interlock is provided to shut down HF transfer if the B-1 Wing scrubber becomes inoperable. (Consideration is being given to hardwiring the dock interlock.) In addition, noncredited interlocks and alarms are provided via the HFSS distributed control system.

¹⁴ OSR will be revised to include this constraint

¹⁵ *ibid.* 13, Section 3/4 6

Technical Baseline Effort

The HFSS technical baseline effort will provide assurance that the as-built configuration of the HFSS meets the appropriate safety/design/operational requirements and is properly reflected in configuration controlled documents¹⁶. The effort is depicted in the logic diagram below. Over 350 requirements have been identified, and the design output paper reviews are nearing completion. Field walkdowns will confirm as-built conditions and, where necessary, start-up testing will be completed.

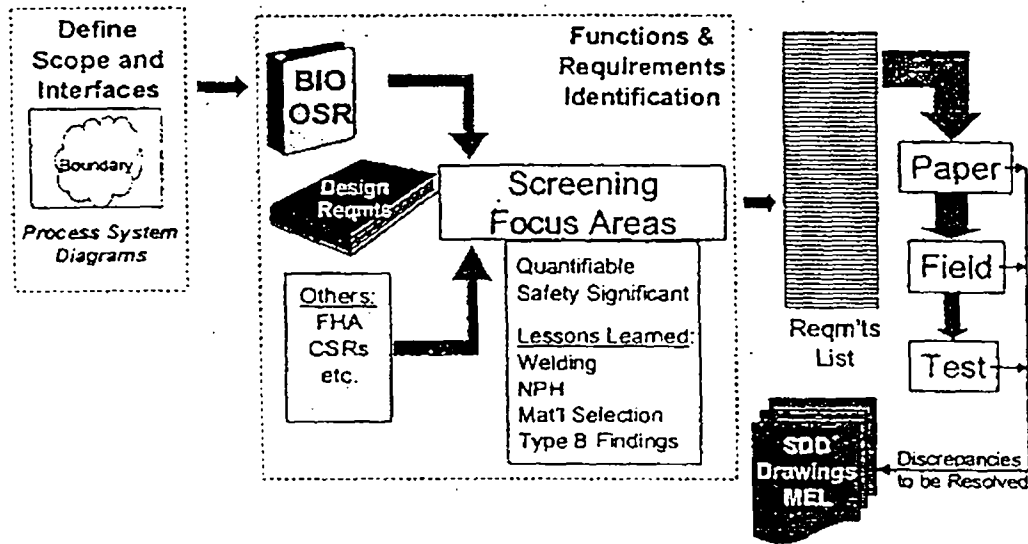

Three areas are receiving special attention during the technical baseline effort:

- Process Hazards Analysis – an independent overview by chemical process safety management experts will be performed to ensure that previous process hazards analyses and the general HFSS design meets or exceeds chemical industry practices.
- Instrumentation and Controls – specific design criteria for safety-related instrumentation will be developed using industry standards. Existing instrumentation will be evaluated and discrepancies will be resolved.
- Natural Phenomena Hazards – the design criteria applied to HFSS for resistance against natural phenomena (earthquakes, wind, etc.) has been revised. Systems, structures, and components will be evaluated to ensure that they meet the necessary design criteria (including I/I interactions).

including confirmation & isolation?

Each baseline requirement will have a documentation package that provides objective evidence that the requirement is met by the as-built HFSS. Discrepancies will be evaluated and resolved, as necessary, prior to testing or startup of the HFSS.

¹⁶ ibid. 3

Integrated Safety Control Set

As described in DNFSB/TECH-16, *Integrated Safety Management*,¹⁷ the tailoring of hazard controls must reach across a wide variety of programs. The third level of defense-in-depth involves programs ranging from training and procedures to personal protective equipment. For the HFSS, as the potential for harm increases, the safety assurance measures increase in number and intensity. This layering of controls provides the necessary defense-in-depth and is depicted below. To ensure that this integrated safety control set works (satisfying the 'how safe is safe enough' challenge), Y-12 has and will continue to involve personnel with expertise in the hazardous materials and processes involved and the practices that are commonly used to ensure the safety of the public, workers, and the environment.

	Engineered Design Features	Administrative Controls	Work Practice	PPE
Public	'Wetted' Boundary Secondary Confinement Scrubbers Interlocks	OSR Limits & Surv. USQD, FP, QA, etc. Configuration Mgmt. <i>Emergency Mgmt.</i> <i>Maintenance Prog.</i>	<i>Ops. Training</i> <i>Ops. Qualification</i> <i>Cat I Procedures</i> <i>Assessments</i> <i>Procurement Control</i> <i>Conduct of Operations</i>	
Worker	Same as above Control System HF Detectors/Alarms	Same as above Industrial Hygiene	Same as above Lock Out/Tag Out JHA/JHI	<i>Respirators</i> <i>Chem</i> <i>Detectors</i>
Environs	Same as above	Same as above	Same as above	

Italicized items still in development.

¹⁷ DNFSB/TECH-16, *Integrated Safety Management*, Defense Nuclear Facilities Safety Board Technical Report, June 1997